

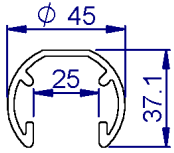

PROFILE GUIDE.



PM01

USAGE: Condenser Mount
LENGTH: 5800mm

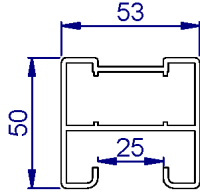

PM02

USAGE: Support Rail
LENGTH: 5800mm

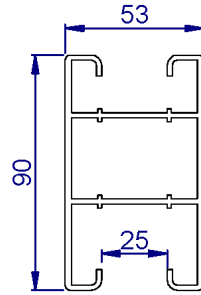

PM03

USAGE: Support Rail
LENGTH: 5800mm

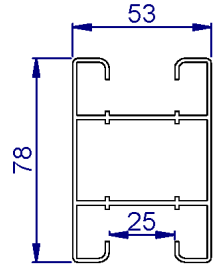

PM06

USAGE: Support Rail
LENGTH: 5800mm

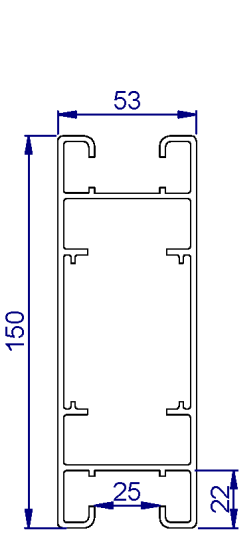

PM07

USAGE: Support Rail
LENGTH: 3000mm, 5000mm

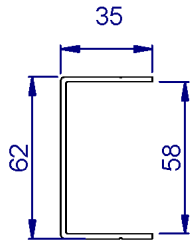

PM08

USAGE: Stanchion Backstay
LENGTH: 5800mm

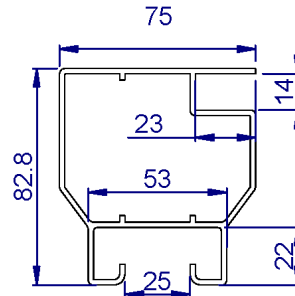

PM09

USAGE: Smartwalk Stringer
LENGTH: 4800mm, 6000mm

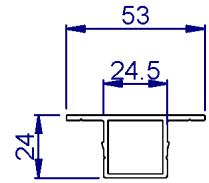

PM10

USAGE: Condenser Mount Upright, Louvre, Perforated Screen To Stanchion Connection
LENGTH: 5800mm

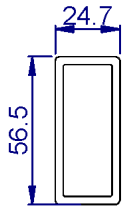

PM11

USAGE: PM09 Joiner, Welded Truss Member
LENGTH: 5800mm

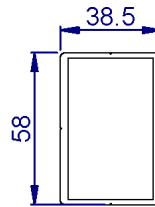

PM13

USAGE: Handrail Stanchion
LENGTH: 5800mm

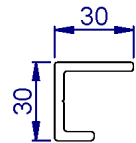

PM14

USAGE: Smartwalk Member
LENGTH: 5800mm

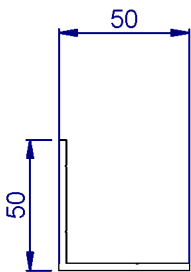

PM16

USAGE: Brace
LENGTH: 5800mm

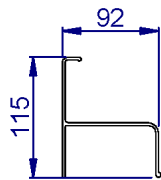

PM19

USAGE: Roof Hatches
LENGTH: 5000mm

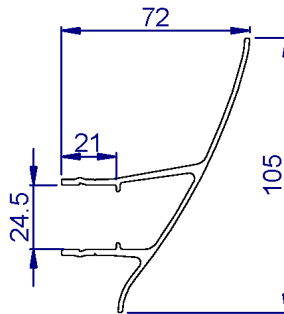

PM20

USAGE: Louvre
LENGTH: 6000mm

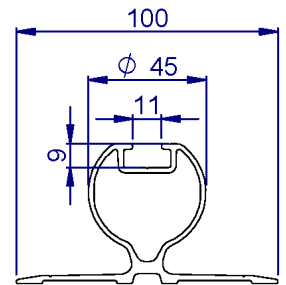

PM21

USAGE: Condenser Mount Support
LENGTH: 6000mm

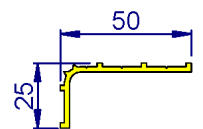
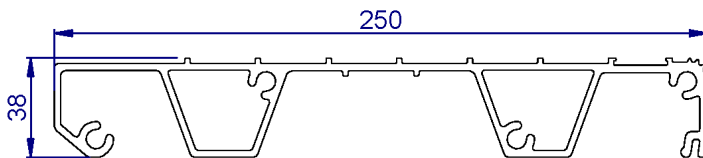
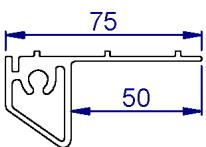



PROFILE GUIDE.

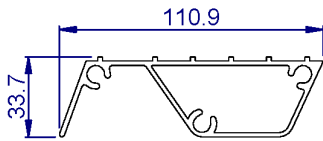

PM28
USAGE: Stepladder Tread
LENGTH: 5000mm

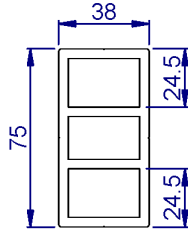

PM29
USAGE: Heavy Duty Handrail Stanchion
LENGTH: 5000mm

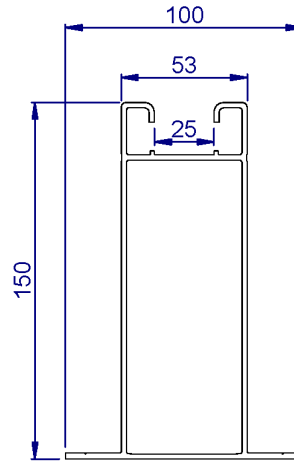

PM34
USAGE: Screen Support/Heavy Duty Rail
LENGTH: 5800mm

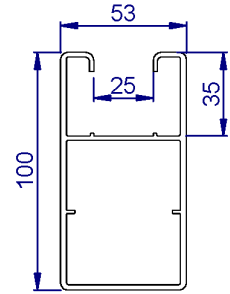

PM35
USAGE: Truss Member, Tape Down Support Rail
LENGTH: 6100mm

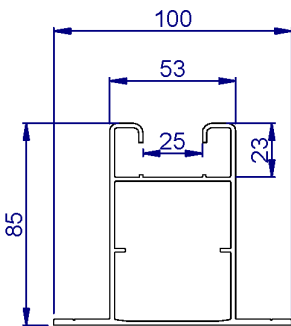

PM36
USAGE: Tape Down Support Rail
Truss Member, Mesh Support
LENGTH: 6100mm

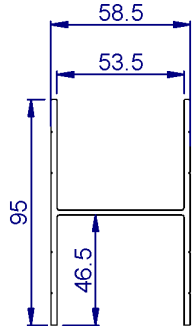

PM37
USAGE: Truss Member, Joiner For MKT Extrusions
LENGTH: 6000mm

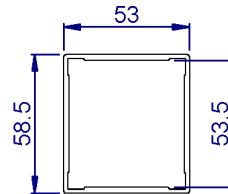

PM38
USAGE: Truss Member, Joiner For MKT Extrusions
LENGTH: 6000mm

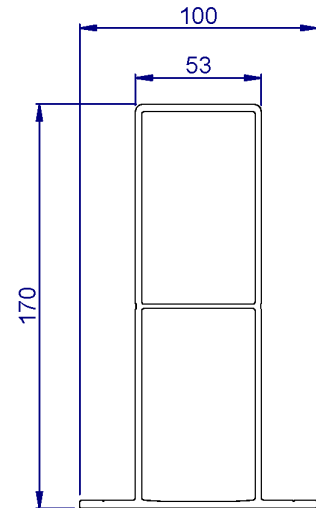

PM39
USAGE: Heavy Duty Rail
LENGTH: 4000mm, 6000mm

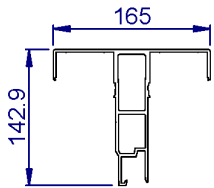

PM40
USAGE: X-Beam Flange
LENGTH: 11000mm

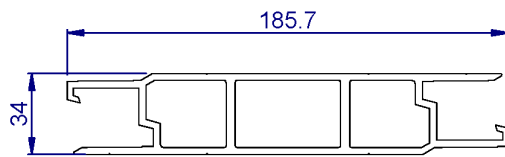

PM41
USAGE: X-Beam Web Section
LENGTH: 11000mm

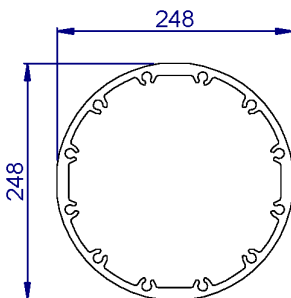

PM50.W6
USAGE: Support Column For X-Beams
LENGTH: 4000mm

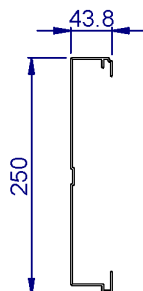

PM51
USAGE: Hushmonkey Acoustic Panel
LENGTH: 4810mm

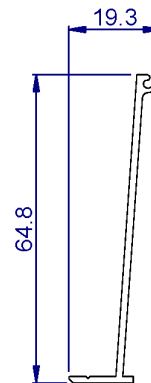

PM43
USAGE: X-Beam Cap
LENGTH: 11000mm

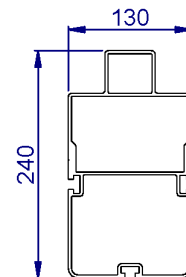

PM45
USAGE: Acoustic Screens
LENGTH: 4800mm



PROFILE GUIDE.

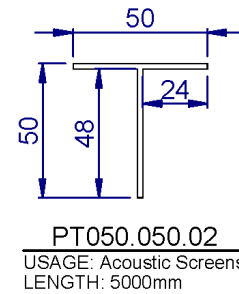
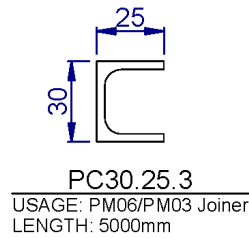
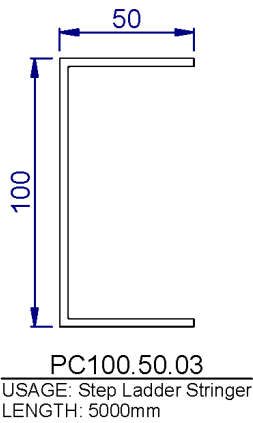
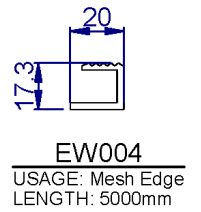
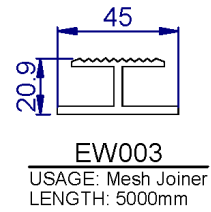
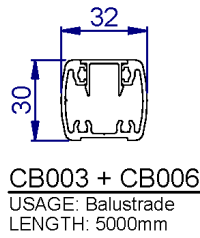
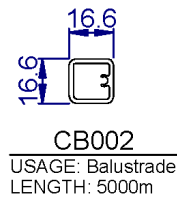
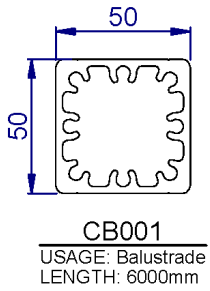
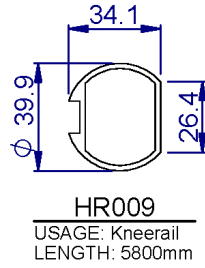
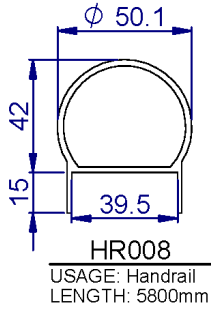



PROFILE GUIDE.

| STOCKED PIPE | | | |
|--------------|-----------------|------------|----------|
| CODE | DESCRIPTION | MAX LENGTH | \$/METER |
| PP32.3 | 32 x 3mm Pipe | 5000mm | \$5.34 |
| PP38.3 | 38 x 3mm Pipe | 5000mm | \$5.43 |
| PP48.32 | 48 x 3.2mm Pipe | 5000mm | \$7.49 |
| PP50.3 | 50 x 3mm Pipe | 5000mm | \$8.34 |

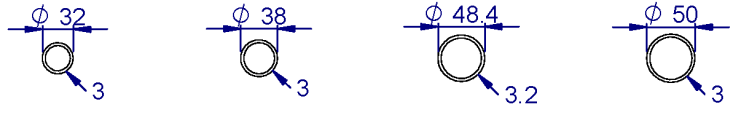

| STOCKED EQUAL ANGLE | | | |
|---------------------|------------------------|------------|----------|
| CODE | DESCRIPTION | MAX LENGTH | \$/METER |
| PA025.025.03 | 25 x 3mm Equal Angle | 5000mm | \$2.16 |
| PA030.030.05 | 30 x 5mm Equal Angle | 5000mm | \$5.08 |
| PA050.050.05 | 50 x 5mm Equal Angle | 5000mm | \$7.44 |
| PA060.060.06 | 60 x 6mm Equal Angle | 5000mm | \$11.27 |
| PA075.075.03 | 75 x 3mm Equal Angle | 5000mm | \$10.15 |
| PA075.075.06 | 75 x 6mm Equal Angle | 5000mm | \$14.21 |
| PA100.100.06 | 100 x 6mm Equal Angle | 5000mm | \$18.84 |
| PA100.100.10 | 100 x 10mm Equal Angle | 5000mm | \$31.28 |

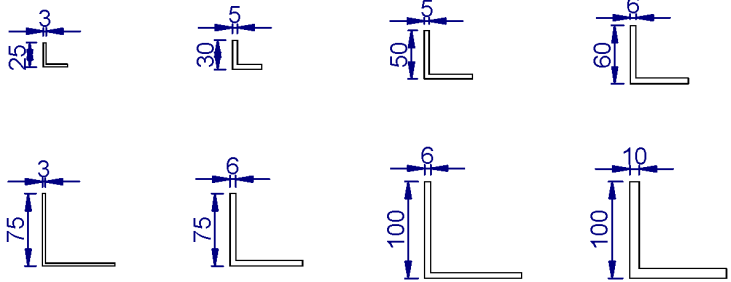

| STOCKED UNEQUAL ANGLE | | | |
|-----------------------|----------------------|------------|----------|
| CODE | DESCRIPTION | MAX LENGTH | \$/METER |
| PA075.025.03 | 75 x 25 x 3mm Angle | 5000mm | \$4.77 |
| PA075.050.06 | 75 x 50 x 6mm Angle | 5000mm | \$16.45 |
| PA100.050.06 | 100 x 50 x 3mm Angle | 5000mm | \$8.23 |
| PA100.050.06 | 100 x 50 x 6mm Angle | 5000mm | \$14.80 |
| PA150.075.03 | 150 x 75 x 3mm Angle | 5000mm | \$15.28 |
| PA150.075.06 | 150 x 75 x 6mm Angle | 5000mm | \$22.15 |

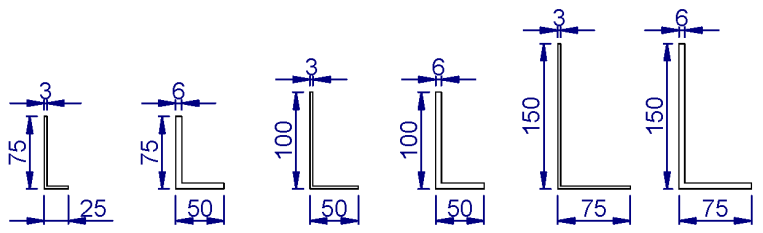

| STOCKED FLAT BAR | | | |
|------------------|---------------------|------------|----------|
| CODE | DESCRIPTION | MAX LENGTH | \$/METER |
| PF025.03 | 25 x 3mm Flat Bar | 5000mm | \$1.22 |
| PF025.10 | 25 x 10mm Flat Bar | 5000mm | \$3.94 |
| PF038.06 | 38 x 6mm Flat Bar | 5000mm | \$3.75 |
| PF050.06 | 50 x 6mm Flat Bar | 5000mm | \$4.50 |
| PF050.08 | 50 x 8mm Flat Bar | 5000mm | \$6.76 |
| PF050.10 | 50 x 10mm Flat Bar | 5000mm | \$8.24 |
| PF075.03 | 75 x 3mm Flat Bar | 5000mm | \$3.78 |
| PF075.06 | 75 x 6mm Flat Bar | 5000mm | \$6.51 |
| PF075.10 | 75 x 10mm Flat Bar | 5000mm | \$17.27 |
| PF100.06 | 100 x 6mm Flat Bar | 5000mm | \$9.88 |
| PF100.10 | 100 x 10mm Flat Bar | 5000mm | \$16.53 |
| PF150.06 | 150 x 6mm Flat Bar | 5000mm | \$14.82 |
| PF150.10 | 150 x 10mm Flat Bar | 5000mm | \$24.71 |
| PF200.10 | 200 x 10mm Flat Bar | 5000mm | \$30.89 |

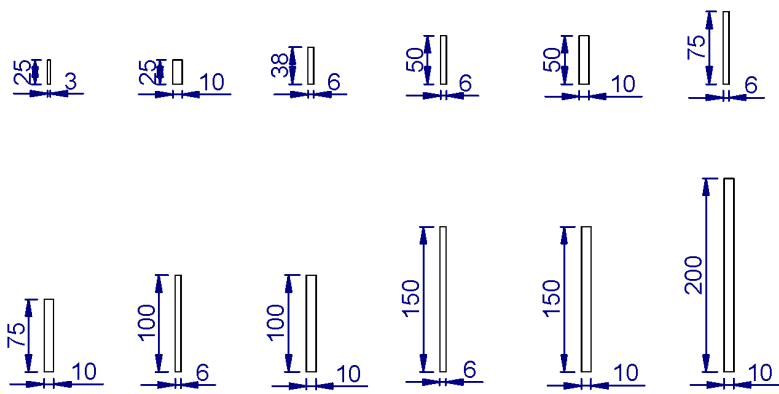

| STOCKED SQUARE HOLLOW SECTION | | | |
|-------------------------------|---------------|------------|----------|
| CODE | DESCRIPTION | MAX LENGTH | \$/METER |
| PR50.050.3 | 50 x 3mm SHS | 5000mm | \$9.02 |
| PR50.050.5 | 50 x 5mm SHS | 5000mm | \$20.73 |
| PR75.075.3 | 75 x 3mm SHS | 5000mm | \$15.04 |
| PR75.075.6 | 75 x 6mm SHS | 5000mm | \$19.83 |
| PR100.100.6 | 100 x 6mm SHS | 5000mm | \$33.44 |

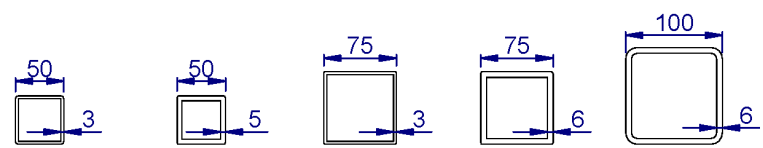

| STOCKED RECTANGULAR HOLLOW SECTION | | | |
|------------------------------------|--------------------|------------|----------|
| CODE | DESCRIPTION | MAX LENGTH | \$/METER |
| PR100.050.3 | 100 x 50 x 3mm RHS | 5000mm | \$14.16 |
| PR100.050.6 | 100 x 50 x 6mm RHS | 5000mm | \$27.27 |

